



The world's largest manufacturer of locks Assa has developed the Assa Desmo as it's top of the range camlock product. With many of the world's largest casino groups as a customer the product has become a standard of any casino operator who insist on maximum security combined with maximum operating comfort.

Last years launch of the RC (removable core) version has made this line complete; the casino operator has now both maximum security and economic handling united in one product.



The Assa Desmo is a patented lock construction based on direct drive pins (no spring operation) making it particularly suitable for many operations in dirty and hostile environments.

False cuts on the pins provide resistance to any currently known method of picking. A large key made from nickel silver provides many years of guaranteed comfortable handling.



The Assa Desmo system is the effective way to prevent unauthorized manufacturing, cutting and distribution of key blanks, it also requires the most advanced and precise key cutting equipment in the lock industry.

No key blanks for Assa Desmo are sold and key production for Europe is only done in Sweden.

Desmo Casino Locks

Features:

- 8-pin lock combined with two strong side bars.
- Patent protected against unauthorized key duplication.
- False cuts on the pins provide extra resistance to any known method of picking.
- Large key made of nickel silver for lasting durability and comfortable operation.
- Standard 90 degrees operation and key removable in locked position, optionally available with removable key in either locked or unlocked position.
- Various collars available to adjust any mounting depth. Lock 1-1/8" 28.5mm.
- Switchlocks available in same keycode as standard camlock.
- Standard supplied with 32mm cam, other sizes and models available.

* Key alike, minimum quantity 25 pcs.

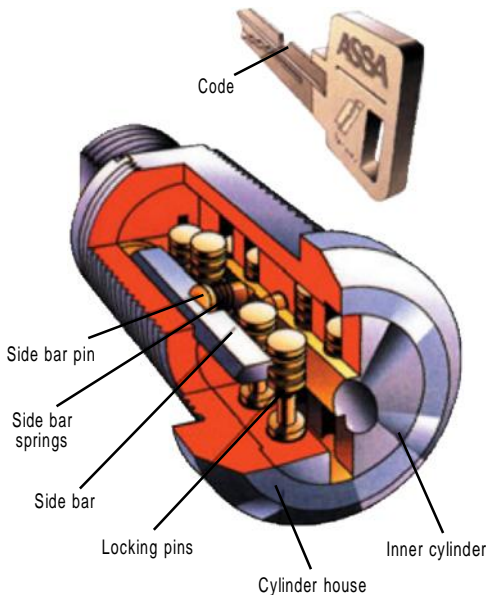
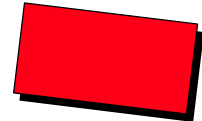

| Part no. | Description |
|-------------|---|
| D1118KA* | Desmo Casino lock 28.5mm (1-1/8") key alike |
| D1118KD | Desmo Casino lock 28.5mm (1-1/8") key different |
| D1118KA-AD | Desmo Casino lock 28.5mm (1-1/8") key alike 2 pull out positions |
| D1118KA2-AD | Desmo Casino lock 28.5mm (1-1/8") key alike as set of 2 pieces 1 with 1 pull out position and 1 with 2 pull out positions |

Assa Desmo Switchlocks

| Part no. | Description |
|-----------|--|
| DSW2000KA | Desmo switchlock 43.5mm long key alike |
| DSW2000KD | Desmo switchlock 43.5mm long key different |

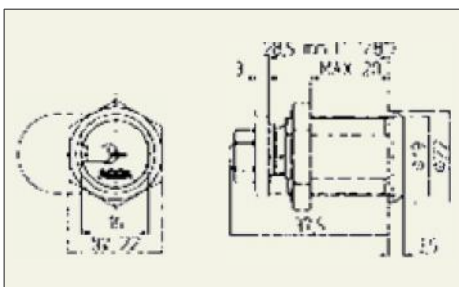

The use of collar PC2 will shorten the lock to 22.3mm



The use of collar 22-0904 will shorten the lock to 15.9mm

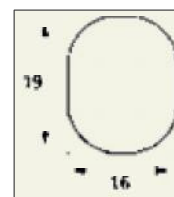

Hole size (mm)

Note:
The key must be withdrawn before fitting of lock and catch.
Maximum torque 4 Nm.



Assa Desmo Camlock with Removable Core



Assa Desmo Switchlock with Removable Core



Assa Desmo Removable Cores with Colour Identification



Assa Desmo RC Management Keys



Assa Desmo RC Operating Keys

| Part no. | Description |
|-----------|--------------------|
| D3001 | Housing switchlock |
| D3118 | Housing camlock |
| D4118-XXX | Core |
| D5001-XXX | Operator key |
| D5002-XXX | Management key |

Minimum Serial Lock Order Policy

For new key-alike series:
Minimum 25 Locks*
For re-orders on existing series:
Minimum 10 Locks
(*Except by multiple series for example multi-player machines)

ASSA®



Assa Desmo RC (Removable Core)

Based on the success of the Assa Desmo locks, Assa has recently developed a version of this lock with removable core. This version makes it possible to change the inner part where the key code is with the ease of a key operation, in literally seconds the core with the key code can be removed or installed in a lock housing with the use of your special management key from Assa Desmo. Making pre-installations of the locks simple and safe. In the case of a lost operator key, changing the lock into another key-code is easy, fast and available at a fraction of the price of a complete new lock. An optionally supplied service tool makes it possible for service and manufacturing companies to open and close the lock comfortably as long as the final core with the key-code is not installed. Suzo and Assa jointly developed an optional colour code system for both core and key for easy recognition when the core is removed from the lock housing.

Assa Desmo RC

Features:

- 6 Pin lock with two strong side bars.
- Patent protected against unauthorised key duplication
- False cuts on the pins provide extra resistance to any known method of picking.
- Easy to replace core by using a special management key, this management key has three different code heights available for the removal function.
- To achieve an easy re-keying, the pins are mounted from one side and covered by a removable cover plate.
- Large key made of nickel silver for lasting durability and comfortable operation.
- Standard 90 degree operation and key removable in locked position, optionally available with removable key in either locked or unlocked position.
- Various collars available to adjust any mounting depth.
Lock 1-1/8" 28.5mm
- RC Switchlock available in same keycode as RC camlock
- Standard supplied with 32mm cam, other sizes and models available.



Lock Spacer

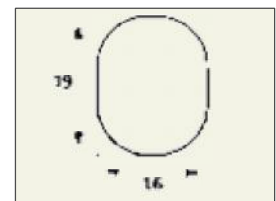

Hole size (mm)

- Takes up extra spaces under head of lock to provide snug fit.

| Part no. | Description |
|----------|---------------------------------|
| FC1 | Lock spacer collar, 1mm collar |
| FC2 | Lock spacer collar, 2mm collar |
| FC3 | Lock spacer collar, 3mm collar |
| FC4 | Lock spacer collar, 4mm collar |
| FC5 | Lock spacer collar, 5mm collar |
| FC7 | Lock spacer collar, 7mm collar |
| FC10 | Lock spacer collar, 10mm collar |



Low & Fletcher Refill locks

Immediate replacement for various AWP machines.

| Part no. | Description |
|----------|--------------------------------|
| L87000KA | Refill lock key alike L87000KA |
| 5015014 | Refill lock key different |



Low & Fletcher Cam locks

- Round Tubular lock

| Part no. | Description |
|----------|-------------------------|
| L1078KD | Lock 3/4" key different |
| L1118KD | Lock 1" key different |
| L1148KD | Lock 1/4" key different |



Eurolock Camlocks

Flat key locks, standard available in key different, also available in key alike in various keycodes.

| Part no. | Description |
|-------------|-----------------------------|
| L4078KD | Lock 3/4" key different |
| L4118KD | Lock 1" key different |
| L4048KD | Lock 1-1/4" key different |
| L1118-92250 | Lock 1-1/4" key alike 92250 |



Series 5000 - Double Bitted Lock

- Double bitted lock offer a higher security than single bitted locks.
- Standard style as used on most Pinball games.
- Key turns 90 degrees.
- Key exit in locked position.
- Only available in 22.3mm (7/8") .
- Available as key different or key alike.

| Part no. | Description |
|----------|-----------------------------|
| F5078KA | Key alike 22.3mm - 7/8" |
| F5078KD | Key different 22.3mm - 7/8" |



GEM Tubular Pin Tumbler Lock

Series 1000 - Made by: Fort Lock USA.

- High security 7 Pin tumbler lock with round key.
- Chrome polish die-cast construction.
- Key turns 90 degrees.
- Optional second key - exit available (please specify).
- Key exit in locked position.
- Available in 4 lengths: 16mm (5/8"), 22.3mm (7/8"), 28.6mm (1-1/8") and 38mm (1-1/2").
- Available as key different and key alike.

| Part no. | Description |
|----------|-------------------------------|
| F1058KA | Key alike 16mm - 5/8" |
| F1058KD | Key different 16mm - 5/8" |
| F1078KA | Key alike 22.3mm - 7/8" |
| F1078KD | Key different 22.3mm - 7/8" |
| F1118KA | Key alike 28.6mm - 1-1/8" |
| F1118KD | Key different 28.6mm - 1-1/8" |
| F1148KA | Key alike 38mm - 1-1/2" |
| F1148KD | Key different 38mm - 1-1/2" |



GEM Pin Tumbler Key Switch Lock

Series 1000 - Tubular type.

- This 7 pin tumbler single pole switch lock is available with or without automatic key return feature.
- Key is removable in "Off" position.
- By special request, key is removable in two positions.
- Switch is normally open.
- 110V 7 Amp.
- Lock length : 36.4mm (1-7/16") wire terminals.
- Key alike are supplied with 5 keys per serie.
- Key different are supplied with 2 keys per lock.

| Part no. | Description |
|--------------|------------------------------------|
| FSW2-1138KA | Standard switch lock key alike |
| FSW2-1138KD | Standard switch lock key different |
| FSW20-1138KA | Automatic return lock key alike |
| FSW20-1138KD | Automatic return lock key alike |

All key different locks come with 2 keys.
All key alike locks come with 5 keys per series of 100 pcs. The minimum quantity for key alike locks is 25 pcs.



Mono Push Lock

- 1 Push lock with 2 keys.
- Keys are supplied with blue key guard.
- Standard available in key different.

| Part no. | Description |
|----------|----------------|
| S2200KD | Mono push lock |



8-Track Lock

- One lock with 8 different key combinations.
- Key change can be done at location in seconds.
- Saves buying new locks in case of lost or stolen keys.
- Diecast housing, chrome plated.
- With comfortable key guard for better grip.
- Available in different lengths: 16mm (5/8") - 22.3mm (7/8") and 28.6mm (1-1/8").
- Lock supplied with standard 2 positions cam.
- Standard in series of 25, 50, 100, 250 or more.
- Standard all series are supplied with 5 key sets.

| Part no. | Description |
|----------|----------------------------|
| S8058-X | 8-track lock 5/8" 16mm |
| S8078-X | 8-track lock 7/8" 22.3mm |
| S8118-X | 8-track lock 1-1/8" 28.6mm |

X= Number of locks in series.



STC Inner Cylinder Lock

- Used in combination with T-handle.
- 7-pin tumbler round key lock
- Round chrome finished key.
- Standard available as key different, key alike on special order.

| Part no. | Description |
|-----------|----------------------------|
| SPT1010KD | Spindle lock key different |



MORE SECURITY WITH



How GEMATIC LOCKS work

Thousands of different key combinations available!

All key combinations are registered and reserved for customer's exclusive use.

Combinations can be programmed to any of the 8 positions in any sequence selected.

There is no outward indication as to which combination is the operative one.

Now customers themselves can change the combination of each of their locks, already installed, without removing or unlocking them, as many as 8 times.

Also, locks can be reprogrammed back to any of the original combinations if and when the customer wishes to do so.

Done easily in just a couple of seconds and without any loss of security.

To change combination, just insert the CONTROL KEY at the last position used and change to a new position.

A "click" will be felt and this denotes that the lock had been programmed to a new combination.

The CONTROL KEY does not lock or unlock.

The Standard GEMATIC set consists of lock, 1 key for each of the 8 different combinations and the CONTROL KEY (in gold colour for easy identification).

Keys are purchased separately.

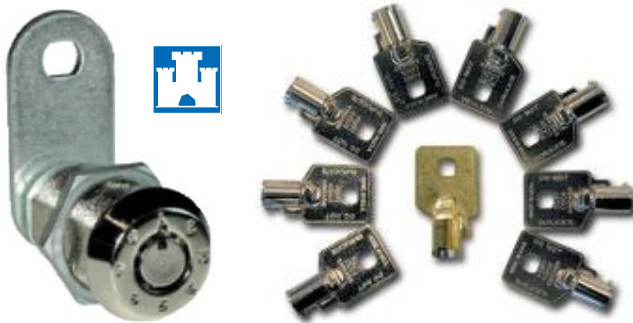

GEMATIC LOCKS are available in sizes: 16mm (5/8"), 22.3mm (7/8") and 28.6mm (1-1/8")
Only in sets of 50 or more available.
Standard supplied with 5 key sets.

| Part no. | Description |
|----------|------------------------------|
| F8GS1058 | Gematic lock 16mm (5/8") |
| F8GS1078 | Gematic lock 22.3mm (7/8") |
| F8GS1118 | Gematic lock 28.6mm (1-1/8") |

Also available as standard switch lock.
(No automatic key return)

| Part no. | Description |
|------------|--------------------------------------|
| F8GS2-1138 | Gematic switch lock 36.4mm (1-7/16") |

VENIA Security Locks



- 14 pin operation.
- Brass housing with high quality spindle.
- Chrome finish.
- Nickel silver key for durability.
- Available as cam lock or switch lock.
- Different lengths 16mm (5/8"), 22.3mm (7/8") and 28.6mm (1-1/8").
- Supplied as key alike and key different.
- Key different locks are supplied with 2 keys per lock.
- Key alike locks in series of 100 or more with 5 keys per serie.
- Protective collar and cam included.
- Also available in series of 10 locks. (multi players)

| Part no. | Description |
|------------|--|
| V1058KA100 | Venia lock 16mm (5/8") key alike |
| V1058KD | Venia lock 16mm (5/8") key different |
| V1078KA100 | Venia lock 22.3mm (7/8") key alike |
| V1078KD | Venia lock 22.3mm (7/8") key different |
| V1118KA100 | Venia lock 28.6mm (1-1/8") key alike |
| V1118KD | Venia lock 28.6mm (1-1/8") key different |

Minimum Serial Lock Order Policy

For new key-alike series: Minimum 25 Locks*

For re-orders on existing series: Minimum 10 Locks

(*Except by multiple series for per example multi-player machines)

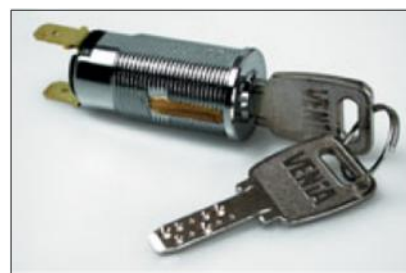

VENIA Switch Locks

- Length 36.4mm (1-7/16")
- Key different is supplied with 2 keys per lock.
- Key alike is supplied with 5 keys per 100 locks.
- Also available with automatic key return.

| Part no. | Description |
|----------------|---|
| VS2-1138KA100 | Switch lock key alike |
| VS2-1138KD | Switch lock key different |
| VS20-1138KA100 | Switch lock automatic return lock key alike |
| VS20-1138KD | Switch lock automatic return lock key different |



KeSet

a total security system



The KeSet range of locks with its unique combination change feature provides you with external protection and internal security.



KeSet tumblers and driving pins are arranged in a manner to defeat picking and manipulation. In addition steel cylinders and hardened plugs resist punching, drilling and vandalism. Cam locks use hardened steel collars for further protection. That is external protection.

In appearance, KeSet is similar to tubular key locks, however, the internal design is quite different.

3 Easy Steps

Follow these simple steps to change combinations. Each lock series permits up to 64 changes. We have over 1 million changes available.



Manager inserts the one key set for existing combination and turns to unlocked or neutral position and removes.



Manager inserts the one key set for existing combination and turns to unlocked or neutral position and removes.



Manager turns the new key to locked position and removes. This set key is retained by manager for future changes.



KeSet Locks

- Locks available in 23mm 7/8" and 30mm 1-1/8" length.

| Part no. | Description |
|-------------|-------------------------|
| N4-2000 | Keset lock 23mm, 7/8" |
| N4-2014-010 | Keset lock 30mm, 1-1/8" |



Collars

- Available in 3 thicknesses.
- Hardened steel with chrome plating.

| Part no. | Description |
|-------------|-----------------------|
| N5-1000-134 | Collar 21.4mm, 27/32" |
| N5-1000-135 | Collar 18.2mm, 23/32" |
| N5-1000-136 | Collar 11.9mm, 15/32" |



Keys

- Set key used for combination change.
- Service key for normal usage.

| Part no. | Description |
|-------------|------------------|
| N4-0803-002 | Service key |
| N4-0804-002 | Set / change key |



Single Bitted Disc Tumbler Lock

- Standard security in the economic price range.
- Brass shell with chrome finish.
- Flat chrome finished key.
- 2 keys per lock.
- Available in 16mm (5/8") 22.3mm (7/8") and 28.6mm (1-1/8")
- Including 1-1/4" straight cam.

| Part no. | Description |
|----------|----------------------------------|
| S3058KD | Lock 16mm 5/8" key different |
| S3078KD | Lock 22.3mm 7/8" key different |
| S3118KD | Lock 28.6mm 1-1/8" key different |

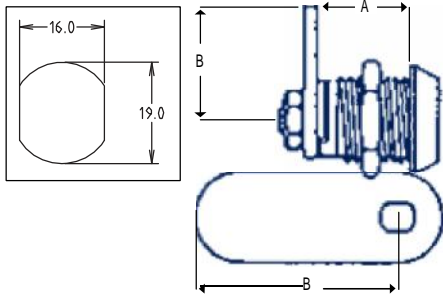

- A. Dimension is the cylinder length. Measure from the back of the lock head to the front of the cam.
- B. Dimension is the cam length. Measure from center of cam hole to tip of cam.



STC Round Key Lock

- 7-pin tumbler lock.
- Brass shell with chrome finish.
- Round chrome finished key.
- Available as key different and key alike.
- Available in 16mm (5/8") 22.3mm (7/8") and 28.6mm (1-1/8")
- Cam included.

| Part no. | Description |
|----------|----------------------------------|
| S1058KA | Lock 16.0mm 5/8" key alike |
| S1058KD | Lock 16.0mm 5/8" key different |
| S1078KA | Lock 22.3mm 7/8" key alike |
| S1078KD | Lock 22.3mm 7/8" key different |
| S1118KA | Lock 28.6mm 1-1/8" key alike |
| S1118KD | Lock 28.6mm 1-1/8" key different |
| S1148KD | Lock 38.0mm 1-1/2" key different |



STC Round Key Lock 2 Sets

- 7-pin tumbler lock.
- Diecast housing, chrome plated.
- Round chrome finished key.
- Set of 2 STC locks same serial number with 2 keys.
- 1 Lock with 1 key pull-out position. (12 o'clock closed)
- 1 Lock with 2 key pull-out positions. (12 o'clock closed and 3 o'clock open).
- Available in 16mm (5/8") and 28.6mm (1-1/8")
- Cam included.

| Part no. | Description |
|-------------|------------------------------|
| S1058KA2-AD | Lock set 2 pcs 5/8" 16mm |
| S1118KA2-AD | Lock set 2 pcs 1-1/8" 28.6mm |



STC Switchlock

- 7-pin tumbler lock.
- Brass shell with chrome finish.
- Round chrome finished key.
- Available as key different and key alike.
- Switch lock supplied with 6.3mm .250" quick connect terminals.
- Available with or without automatic key return.
- Length 36.5mm 1-7/16".

| Part no. | Description |
|------------|---|
| S2-4138KA | Switchlock standard key alike |
| S2-4138KD | Switchlock standard key different |
| S20-4138KA | Switchlock automatic key return alike |
| S20-4138KD | Switchlock automatic key return different |

Minimum Serial Lock Order Policy

For new key-alike series:
Minimum 25 Locks*

For re-orders on existing series:
Minimum 10 Locks

(*Except by multiple series for per example multi-player machines)

All STC key alike locks are supplied in standard series of: 25 - 50 and 100pcs.



Switch Locks

- Key is removable in OFF position only
- Momentary or ON/OFF available
- Double bitted keys are keyed alike #2341 with 2 keys per lock
- Spade terminals
- Barrel length: 27mm
- Overall length: 22mm
- 4 amps/125VAC, 2amps/250VAC

| Part no. | Description |
|-------------|--|
| H30-1086-00 | Momentary switch lock Key is removable only in the OFF position |
| H30-1086-01 | On/Off Switch lock Key is removable only in the OFF position |



STC Switchlock on-off-on

- 7-pin tumbler lock.
- Brass shell with chrome finish.
- Round chrome finished key.
- Available as key different and key alike.
- Length: 36.5mm 1-7/16".

| Part no. | Description |
|-----------|------------------------------------|
| S3-4138KA | On-Off-On Switchlock key alike |
| S3-4138KD | On-Off-On Switchlock key different |



Key Cutting service

We offer fast "In-house" key duplication service for the following locks:
Fort Lock: Gem and Gematic,
STC round key locks and Venia locks.

For duplication please always send us one key and one lock as sample.

| Part no. | Description |
|----------|--|
| S1000 | STC round key customer specification |
| 110-0017 | STC round key blank |
| F1000 | Fort Lock round key customer specification |
| FK137 | Fort Lock round key blank |
| V1000 | Venia key customer specifications |

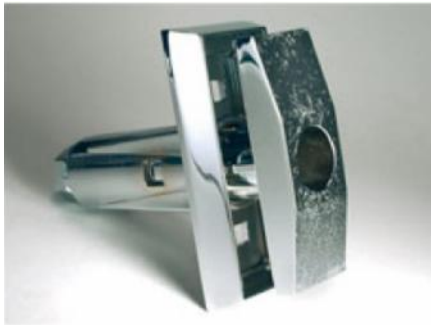

STC T-Handle Assy

- Strong metal construction.
- Bright chrome finish with texture.
- Fits most standard inner cylinder locks.

| Part no. | Description |
|----------|-----------------------|
| SPT1000 | STC T-handle assembly |



DX Padlock - 40mm

- Solid extruded brass case.
- Hardened steel shackle.
- Inox springs inside, 2 keys per lock.
- Lock size 40mm.

| Part no. | Description |
|----------|------------------------|
| BP0002KD | Key different pad lock |



Discus Padlock

- Resistance up to 4000kg of jamming pressure.
- High precision extruded brass cylinder with four mushroom shaped pick resistance brass pins.
- No exposed rivets.
- Case hardened chrome plated shackle.

| Part no. | Description |
|----------|------------------------|
| BP0003KD | Key different pad lock |
| P0003KA | Key alike pad lock |



Key Cutting service

We offer fast "In-house" key duplication service for the following locks:

- Fort Lock: Gem and Gematic,
 - STC round key locks and Venia locks.
- For duplication please always send us one key and one lock as sample.

| Part no. | Description |
|----------|---|
| S1000 | STC round key customer specifications |
| 110-0017 | STC round key blank |
| F1000 | Fort Lock round key customer specifications |
| FK137 | Fort Lock round key blank. |
| V1000 | Venia key customer specifications |



Key Hooks

Packed per 10 pieces.

| Part no. | Description |
|----------|-------------|
| BM389-1 | Key hook |



Anchor Washer

- Zinc plated locking washer.
- To prevent the lock from being turned when installed in a round hole.
- To be used in wooden cabinets.
- Outside diameter \varnothing 34mm.
- Hole size: 19mm. across flat sides
- Thickness: 1mm.

| Part no. | Description |
|----------|---------------|
| AW1 | Anchor washer |



Locking Plate

- Steel zinc plated can be used for all cam locks.
- Size : L 55mm x H 32mm.
- Hole size : 19mm. across flats

| Part no. | Description |
|-----------|---------------|
| BP3473-10 | Locking plate |

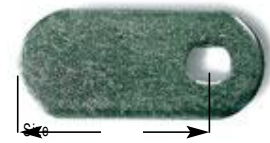

Flat Straight Cams

For locks series 1000 and Assa Desmo with small spindle hole.

| Part no. | Description |
|----------|---------------|
| 105M | 27mm (1") |
| 109M | 32mm (1-1/4") |
| 121M | 50mm (2") |

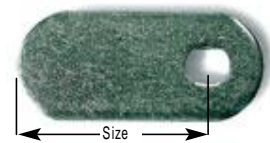

Flat Straight Cams Extra Thin

For locks series 1000 and Assa Desmo with small spindle hole.

- Prevent excessive damage to your expensive cabinet.
- Thickness: 1.5mm.
- Size: 32mm.

| Part no. | Description |
|----------|----------------|
| 109M1 | Cam extra thin |



Off-set Cams Inbending

For locks series 1000.

| Part no. | Description |
|----------|----------------|
| 419M | 37mm inbending |



Hook Cam Outbending

For locks series 1000.

| Part no. | Description |
|----------|-------------|
| A300V | Outbending |

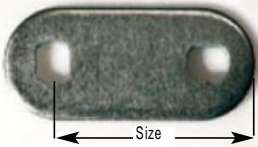

Flat Straight Cams

For locks series 1000 and Assa Desmo.
With 2 spindle holes, so this cam can be mounted in any position.

| Part no. | Description |
|----------|---------------|
| 110-0050 | 32mm (1-1/4") |

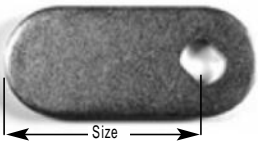

Flat Straight Cams for Assa Desmo Locks with 2 Exits

• Size: 32mm.

| Part no. | Description |
|------------|--------------------------------|
| 110-0055 | Straight cam Assa Desmo normal |
| 110-0055-1 | Straight cam Assa Desmo thin |

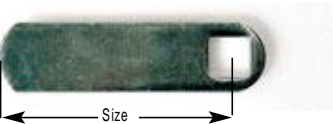

Flat Straight Cams

For locks series 3000 - 6000 - 8000 and 9000.

| Part no. | Description |
|----------|---------------|
| 109NS | 32mm (1-1/4") |



Flat Hook Cams

For locks series 1000 and Assa Desmo.

| Part no. | Description |
|----------|---------------|
| 201M | Flat hook cam |



Flat Hook Cams

For locks series 3000 - 5000 - 6000 - 8000 and 9000.

| Part no. | Description |
|----------|-------------|
| 201NS | Cam no stud |

Model A

Model B



Protective Collars

Hardened steel, nickel plated, tapered edge.

A. This collar shortens your lock with 6.4mm (1/4") and protects the exposed shoulder of the lock from tampering with torsion tools.

Used for locks series 1000 - 3000 and 6000.

B. Shortens your lock 1.6mm (1/16") and protects the exposed shoulder of the lock.

Used for locks series 1000 - 3000 and 6000.

| Part no. | Description |
|----------|-------------|
| 22-0904 | Model A |
| PC2 | Model B |



Lock Spacer

Takes up extra spaces under head of lock to provide snug fit.

| Part no. | Description |
|----------|-------------------------|
| FC1 | Lock spacer collar 1mm |
| FC2 | Lock spacer collar 2mm |
| FC3 | Lock spacer collar 3mm |
| FC4 | Lock spacer collar 4mm |
| FC5 | Lock spacer collar 5mm |
| FC7 | Lock spacer collar 7mm |
| FC10 | Lock spacer collar 10mm |
| FC13 | Lock spacer collar 13mm |



Colour Coded Lock Rings

- For easy identification of lock series.
- Size: 30 x 19 x 0.8mm.
- 6 colours available.
- Made of 0.8mm thick durable plastic.
- Fits all type of cabinet locks shown in this catalogue.
- For use with locks without security collar.
- Sold per bag of 25 pieces.

| Part no. | Description |
|------------|-------------------------------|
| 110-0022 | Colour coded lock ring black |
| 110-0022-2 | Colour coded lock ring red |
| 110-0022-3 | Colour coded lock ring orange |
| 110-0022-4 | Colour coded lock ring yellow |
| 110-0022-5 | Colour coded lock ring green |
| 110-0022-6 | Colour coded lock ring blue |
| 110-0022-8 | Colour coded lock ring grey |
| 110-0022-9 | Colour coded lock ring white |



Key Indicators

Sold per pkg 12 pcs in 6 different colours.

| Part no. | Description |
|----------|----------------|
| 21-2110 | Key indicators |



Key Guard

- For round keys from STC only.
- For better grip.
- Available in 7 colours.

| Part no. | Description |
|------------|------------------|
| 110-0020 | Key guard red |
| 110-0020-3 | Key guard orange |
| 110-0020-4 | Key guard yellow |
| 110-0020-5 | Key guard green |
| 110-0020-6 | Key guard blue |
| 110-0020-8 | Key guard grey |
| 110-0020-9 | Key guard white |
| 110-0020-0 | Key guard black |

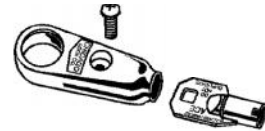

Tubular Key Holder

- Supports and strengthens key to eliminate breakage
- Allows for easier and faster opening of locks
- Fastened with an 8-32 screw included with holder

| Part no. | Description |
|-------------|--------------------|
| H30-1049-00 | Tubular key holder |

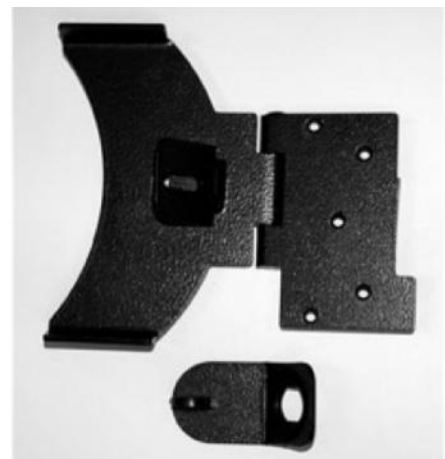

Bat Lock

- For Barcrest Genesis cabinets.
- Padlock not included.

| Part no. | Description |
|----------|-------------|
| 22-0919 | Bat lock |



NEW



Key-Bak Super 48 Key Reel

- Polycarbonate high strength case
- Dust shield keeps interior clean
- Kevlar cable is stronger but lighter than chain and is smooth in action
- Clip/Loop attachment allows dual functionality
- Clip design similar to pistol holsters; meets penal "anti-snatch" rules
- Carries up to 5 times the weight of other retractors
- All black design, high-tech look
- Oversize split ring is standard for larger load
- Corrosion proof for long service life

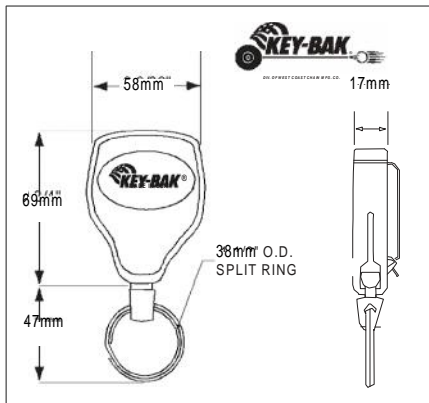

| Part no. | Description |
|-------------|-------------------------------------|
| H30-0101-01 | Super 48 Key Reel with Kevlar cable |

NEW

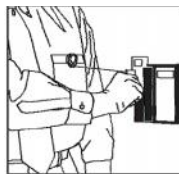

Retract-a-Badge ID Cardholder

- Great for holding security ID cards
- Adds user friendly efficiency to High-tech security
- Steel clip on back allows for easy attachment without damage to clothing
- 30" retractable nylon cord easily allows badge to be extended and swiped without removing
- Construction: 30mm diameter plastic case, steel clip, 75mm nylon cord and vinyl snapclosure cardholder

| Part no. | Description |
|-------------|-------------------------|
| H30-0142-00 | Retract-A-Badge (Black) |
| H30-0142-01 | Retract-A-Badge (White) |
| H30-0142-02 | Retract-A-Badge (Blue) |

Okay's Key Safe

- Ideal for slot mechanics, locksmiths, security people, etc
- Very secure belt loop style with key ring
- Handy and convenient
- Eliminates pocket wear



| Part no. | Description |
|-------------|-----------------|
| H30-0095-00 | Okay's Key Safe |

NEW



Snap Hook Key Ring

- Heavy-duty steel
- Chrome finish

| Part no. | Description |
|-------------|--------------------|
| H30-0096-00 | Snap Hook Key Ring |

NEW



Wrist Coil With Ring

- Superior quality coil always springs back, never loses its shape
- Fits comfortably on wrist
- 22mm nickel plated tempered steel split ring
- Assorted colours: black, dark blue, teal, purple, red and white
- Coil measures 5cm in diameter; stretches to more than 30cm in diameter

| Part no. | Description |
|-------------|----------------------|
| H30-0202-00 | Wrist coil with ring |

NEW



Snap Hook and Key Ring with Coil

- Great for slot technicians or for use with player tracking cards
- Plastic snap hook easily hooks on belt loops or clothing
- Long 50cm vinyl coated coil expands to approximately 5 times its size
- Metal key ring on end for keys or player tracking cards
- Colour: Black

| Part no. | Description |
|-------------|------------------------------|
| H30-0099-01 | Snap hook and ring with coil |

NEW



Large Standard Roll Top Safe

- Heavy duty 3/8" shackle plate
- Will accommodate "Puck" style Padlock, see padlock page in security section
- Large hopper opening 10 x 19cm
- Large 30 x 30 x 53cm Vault size
- Physical size: 30 x 30 x 69cm
- Weight: 32kg, ship via UPS

| Part no. | Description |
|-------------|------------------------------|
| H30-1470-00 | Large standard roll top safe |

NEW



Medium Standard Roll Top Safe

- Roll top opening size 10 x 19cm
- Physical size: 25 x 25 x 28cm
- Heavy 10 gauge steel construction
- Extra heavy duty 3/8" shackle plate
- Compact size
- Weight: 21kg, ship via UPS

| Part no. | Description |
|-------------|-------------------------------|
| H30-0078-00 | Medium standard roll top safe |

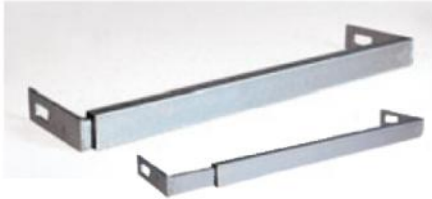

A.W.P. Adjustable HASP

For most A.W.P. and Crane Games

- Easy installation!
- Adjustable from 50 to 90cm (20" to 36").
- Fits onto the front of most games.
- Complete with hardware.
- Zinc plated.
- Will accommodate 2 padlocks, one for each side. (not included)

| Part no. | Description |
|-------------|---------------------|
| H30-0013-01 | AWP adjustable hasp |

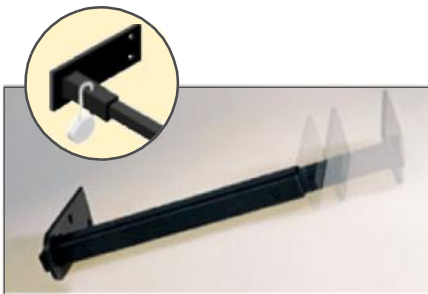

Adjustable Security Bar

For changers, small cabinet and other games

- Easy installation!
- Adjustable from 25 to 40cm. (10" - 16")
- Made from durable steel with black finish.
- Simple mounting with provided hardware.
- When installing is done you only need to drill a 12mm hole in the hasp to fit the padlock. (not included)

| Part no. | Description |
|----------|-------------------------|
| 22-0912 | Adjustable security bar |



Video Hasp 16.5" - 42cm

- Perfect for most video & Arcade machines.
- Installation by drilling of 2 holes.
- Heavy steel construction.
- Zinc plated.
- Complete with hardware.
- Accomodate any size padlock. (not included)

| Part no. | Description |
|-----------|-------------------------|
| 22-0907-1 | Video hasp 16.5" - 42mm |
| BP0003KD | Padlock key different |
| BP0003KA | Padlock key alike |

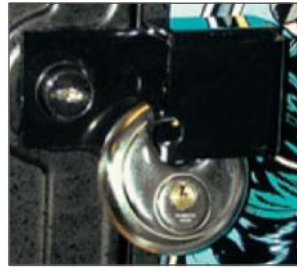

Mini Bar Hasp (4-1/2")

Easy to install on most amusement games

- Easy installation, one hole drilling.
- Black finish.
- 114mm - 4-1/2".
- Hardened steel eye bolts.
- Complete with hardware.
- Accomodate any size padlock. (not included)

| Part no. | Description |
|----------|---------------|
| 22-0910 | Mini bar hasp |



Universal Security Bar

- This security bar is designed to be used with a padlock. (not included).
- Heavy duty steel.
- Telescopic adjustable 40-85cm. (16" - 33")
- Supplied complete with hardware.
- Not recommended for pedestal cabinets.

| Part no. | Description |
|----------|-------------------------|
| 22-0911 | Telescopic security bar |



Flexi Hasp

- Heavy duty construction.
- For use with padlock. (not included).
- Complete with hardware.

| Part no. | Description |
|----------|-------------|
| 22-0914 | Flexi hasp |



Standard 4-1/2" Mini Bar Hasp

- Standard 4-1/2" Bar hasp 1-1/2 wide
- Round hole

| Part no. | Description |
|-------------|---------------|
| H30-1006-00 | Mini bar hasp |

Master Lock Padlock Eyes (Hasps)



Made by Master Lock Company

- Formed at right angles.
- Simple economical way to secure a padlock.
- Hard-wrought 1/8" steel plated.
- Complete with 4 unslotted bolts and nuts per pair. (Padlock not included.)

| Part no. | Description |
|-----------|------------------------------------|
| 34-163000 | Padlock eyes (Minimum order 6 pcs) |



Heavy-Duty T-Handle Protective Cover Assembly

- Heavy 7/64" welded case-hardened steel construction.
- Baked black finish.
- Will accept padlock (not included) with shackle diameter of 7/16" or less.

| Part no. | Description |
|-----------|---------------------------|
| 34-134400 | Protective cover assembly |